

T180 M

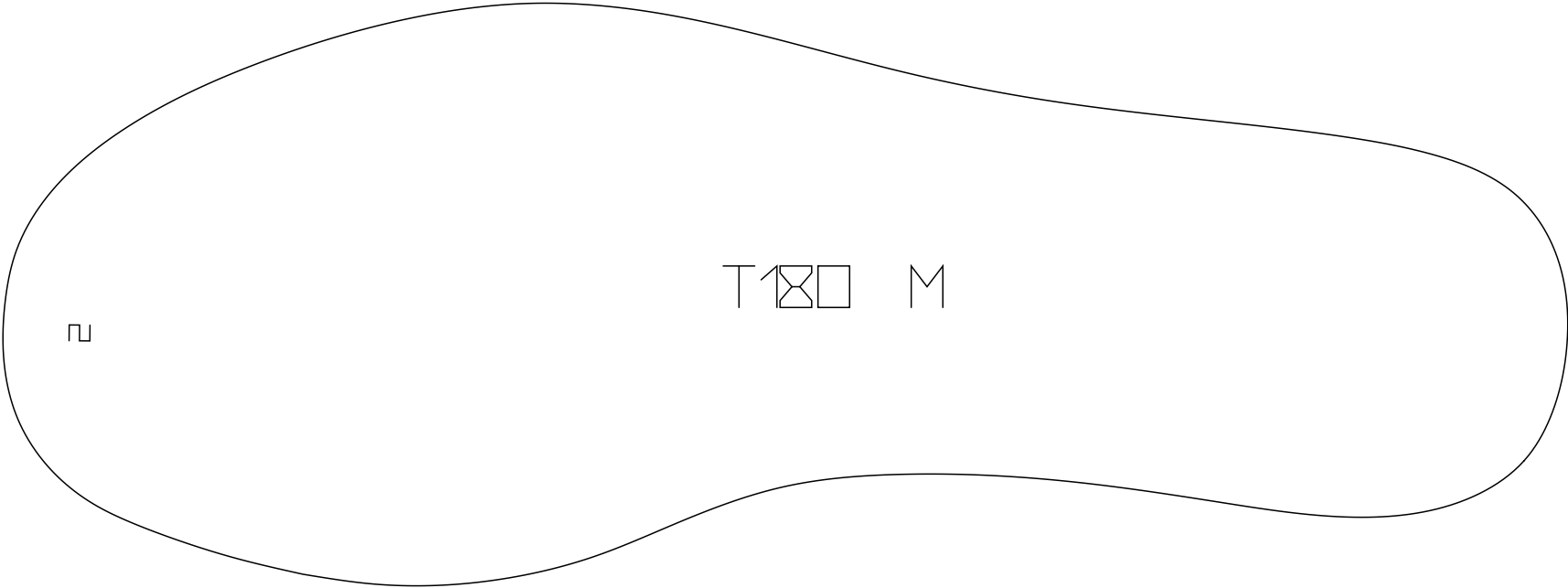



□

T180 M

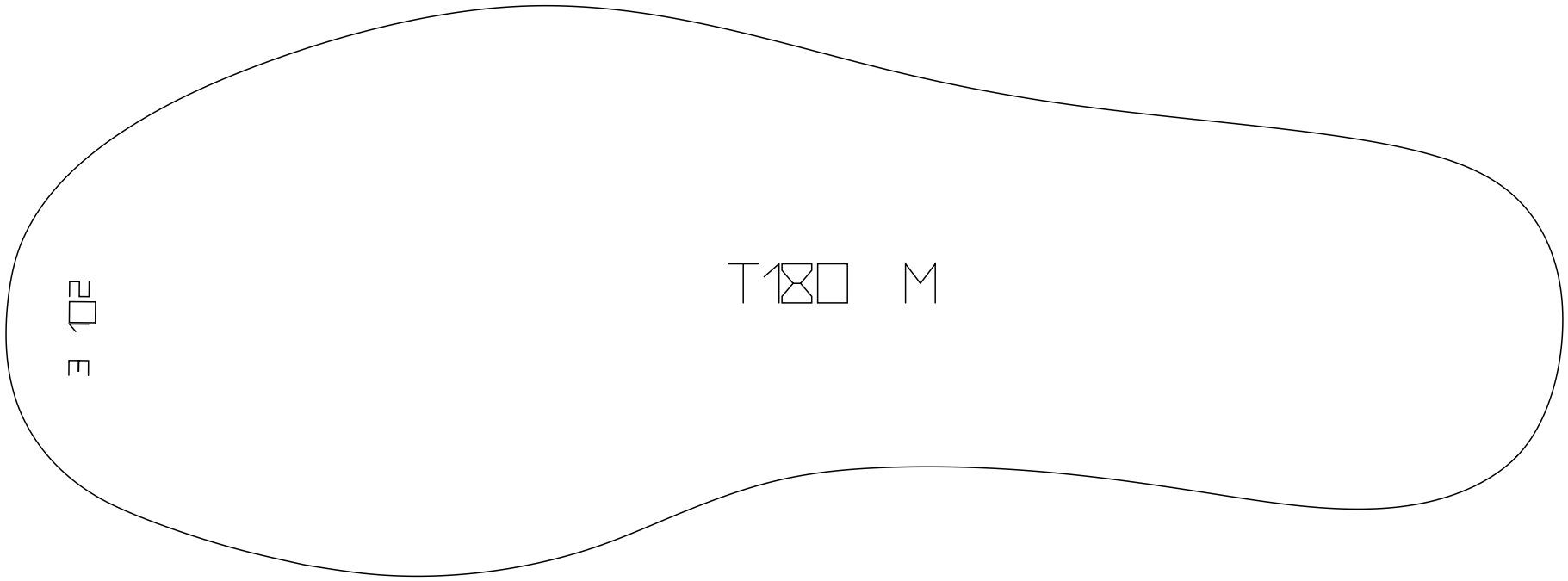

← □  
E

T180 M

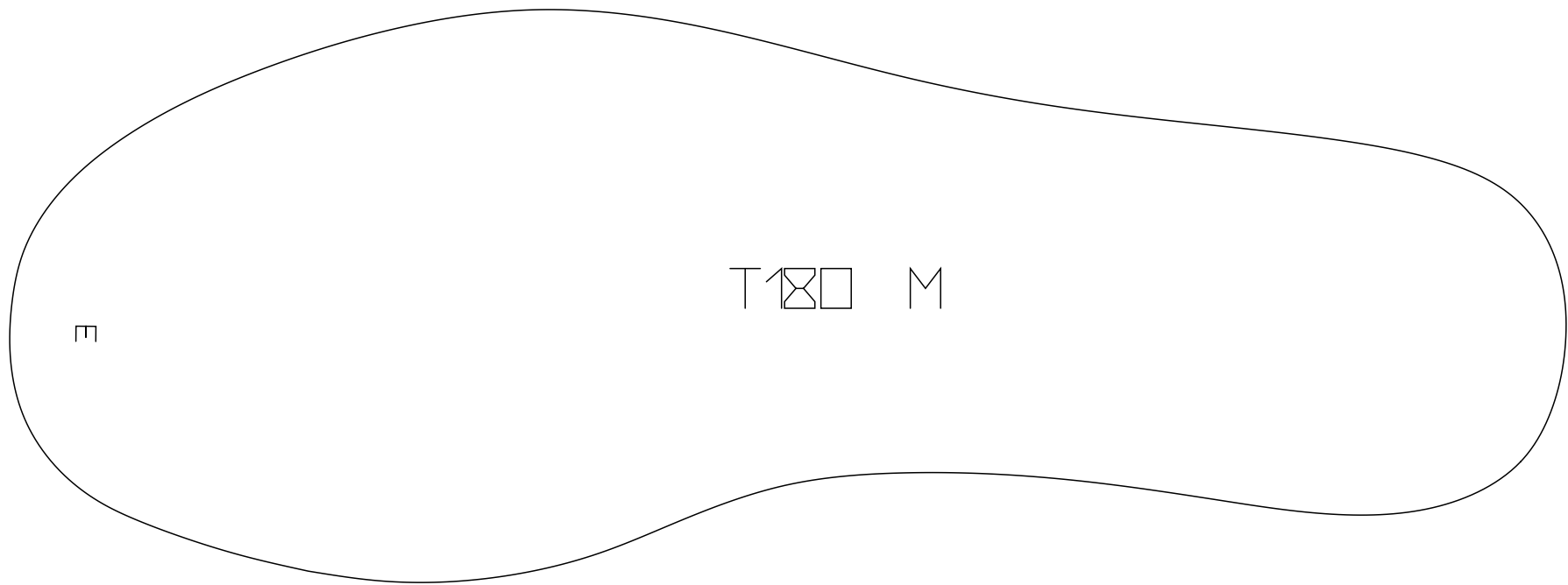

π

T180 M

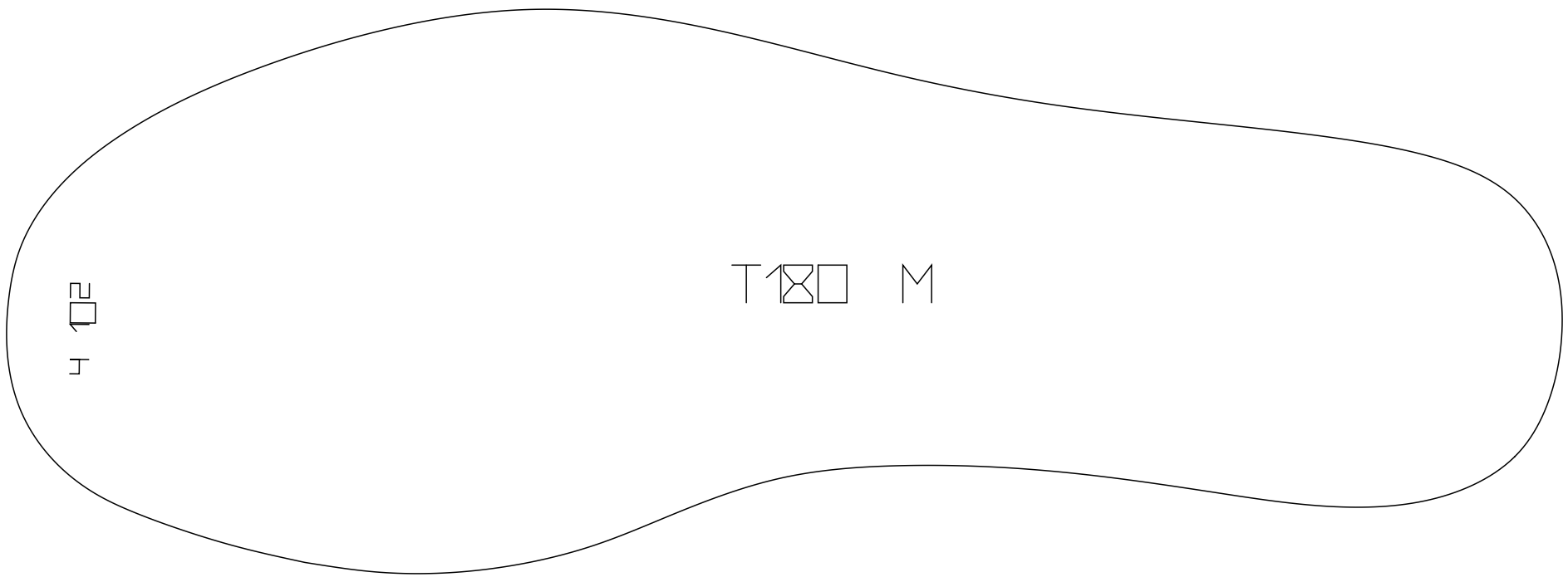

2  
T

T 180 M

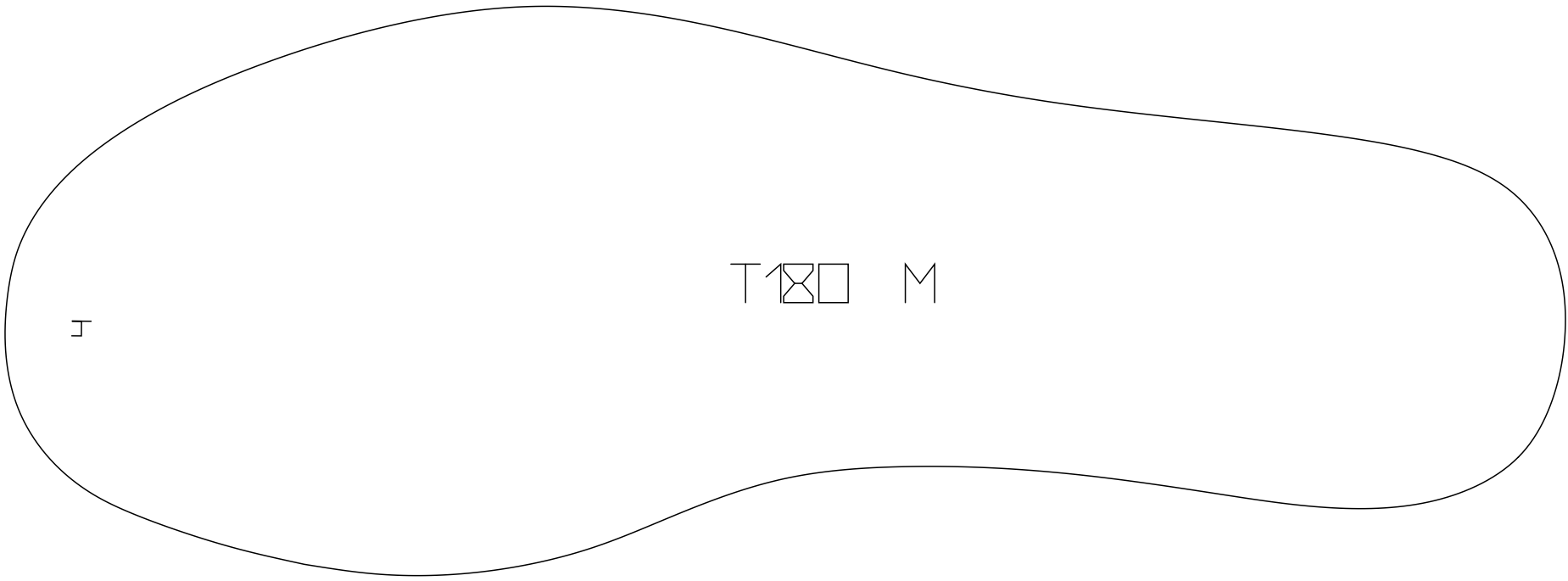

J

T180 M

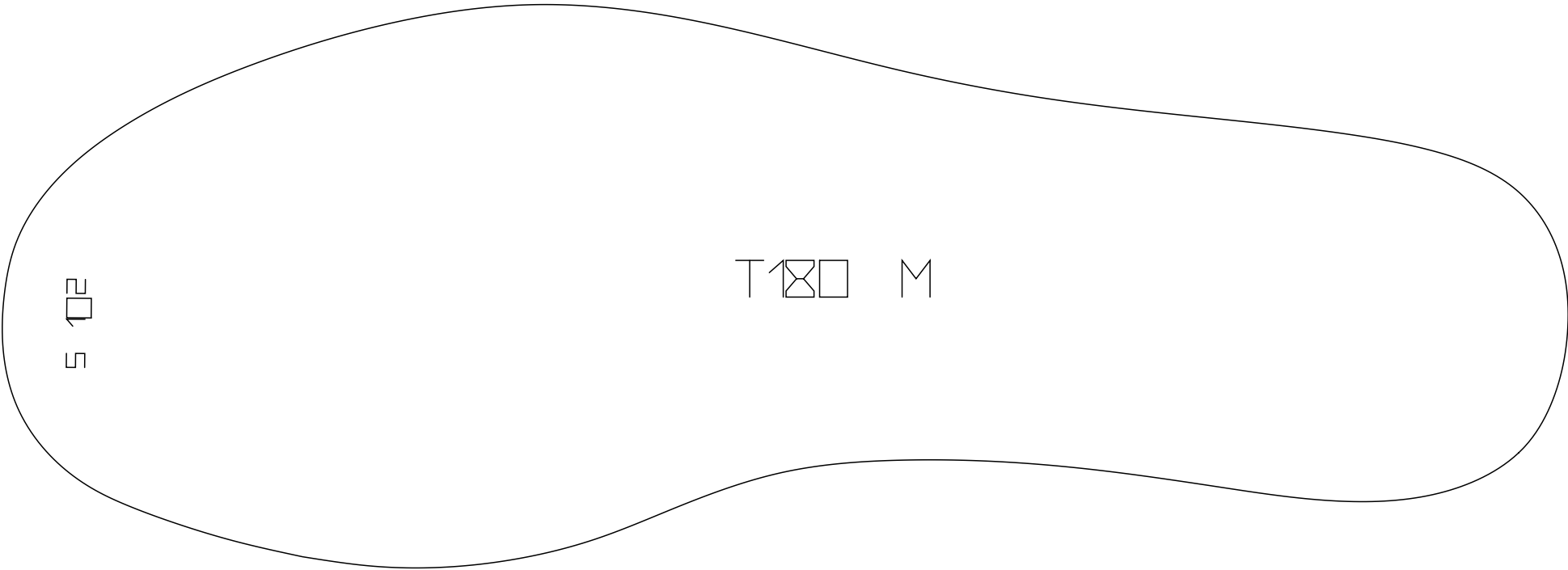

S  
20

T180 M

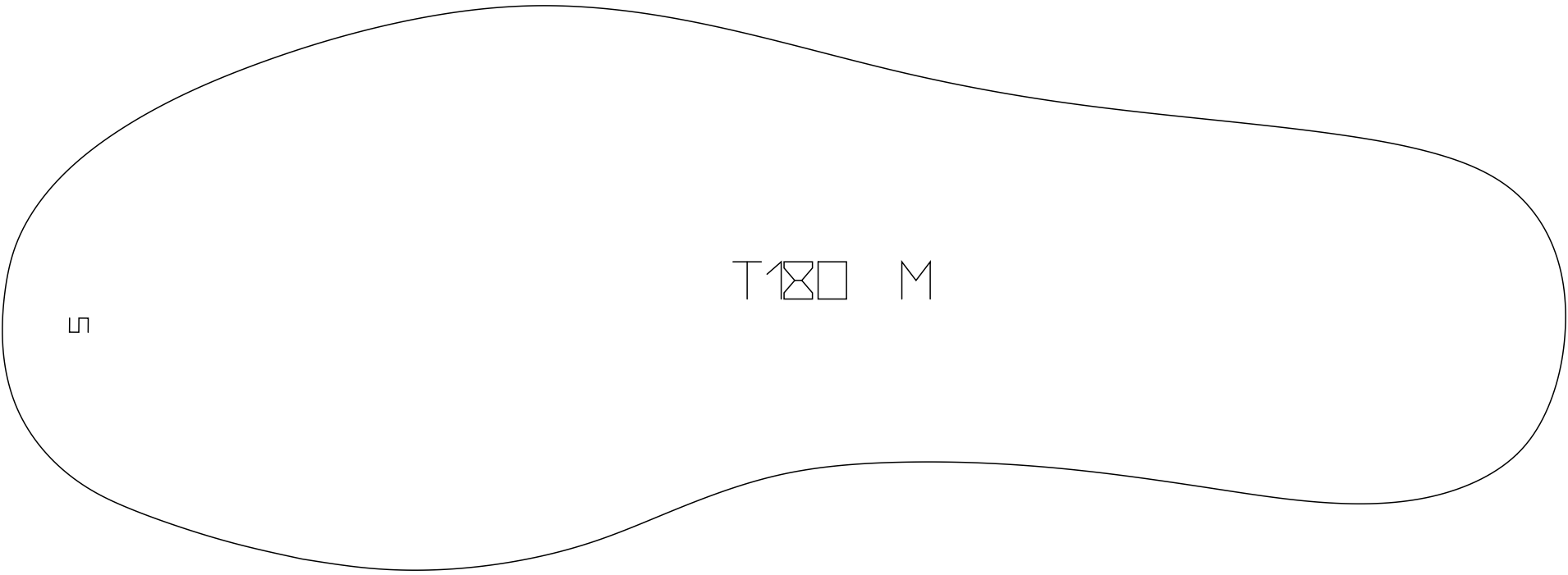

5

T180 M



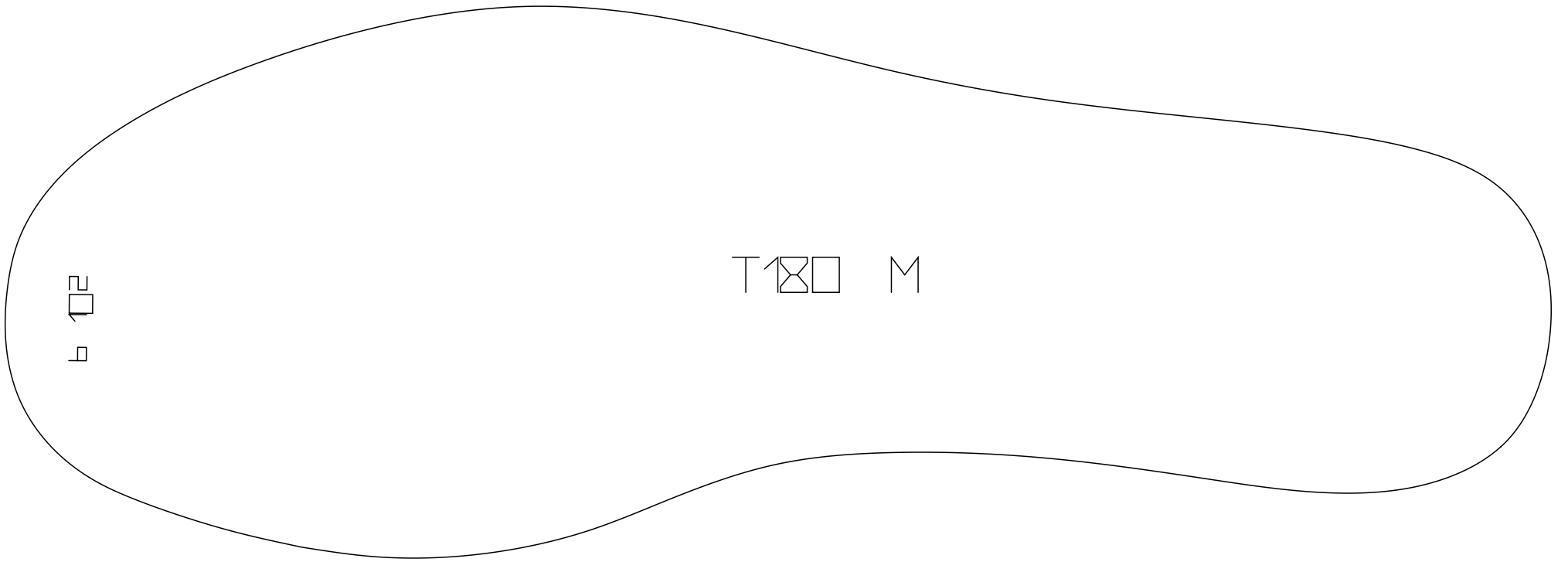

□ 20

□

T180 M

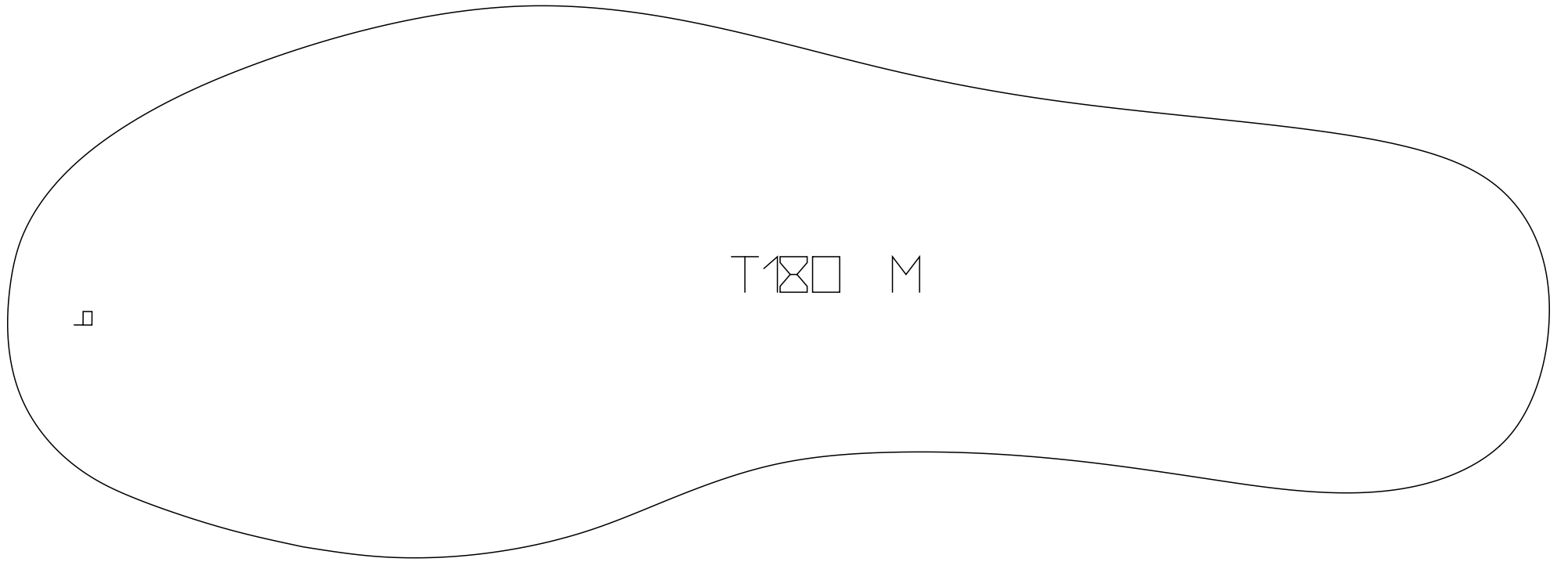

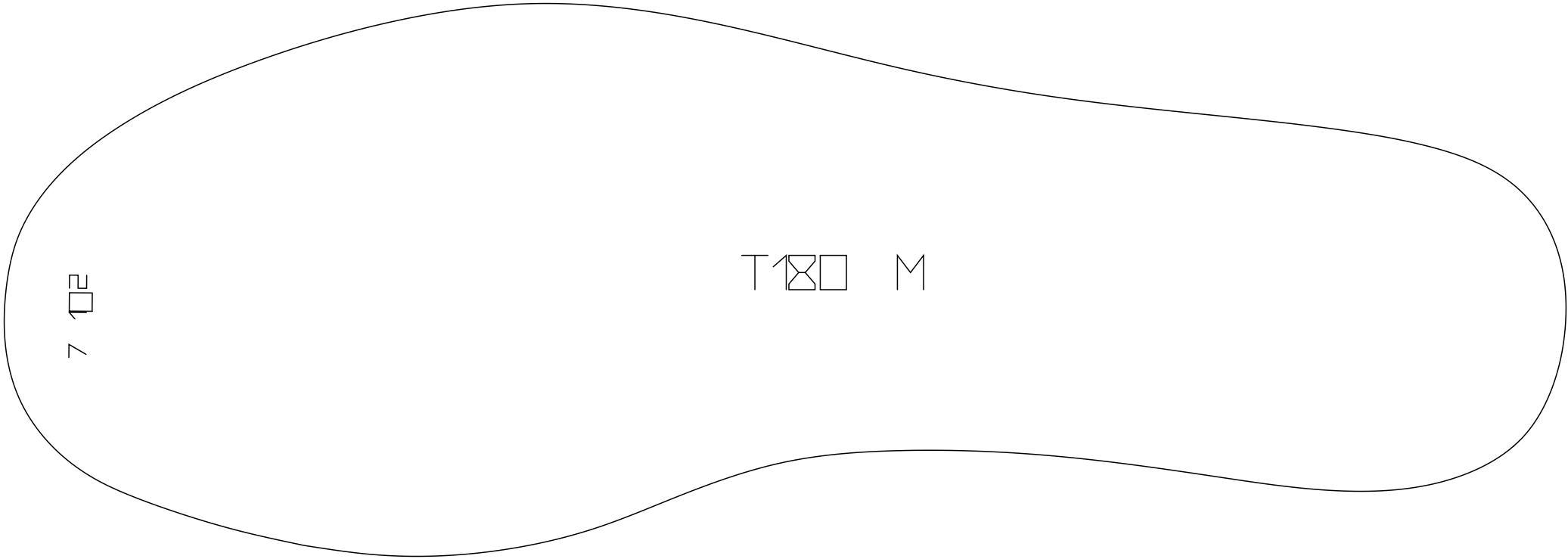

7 102

T180 M

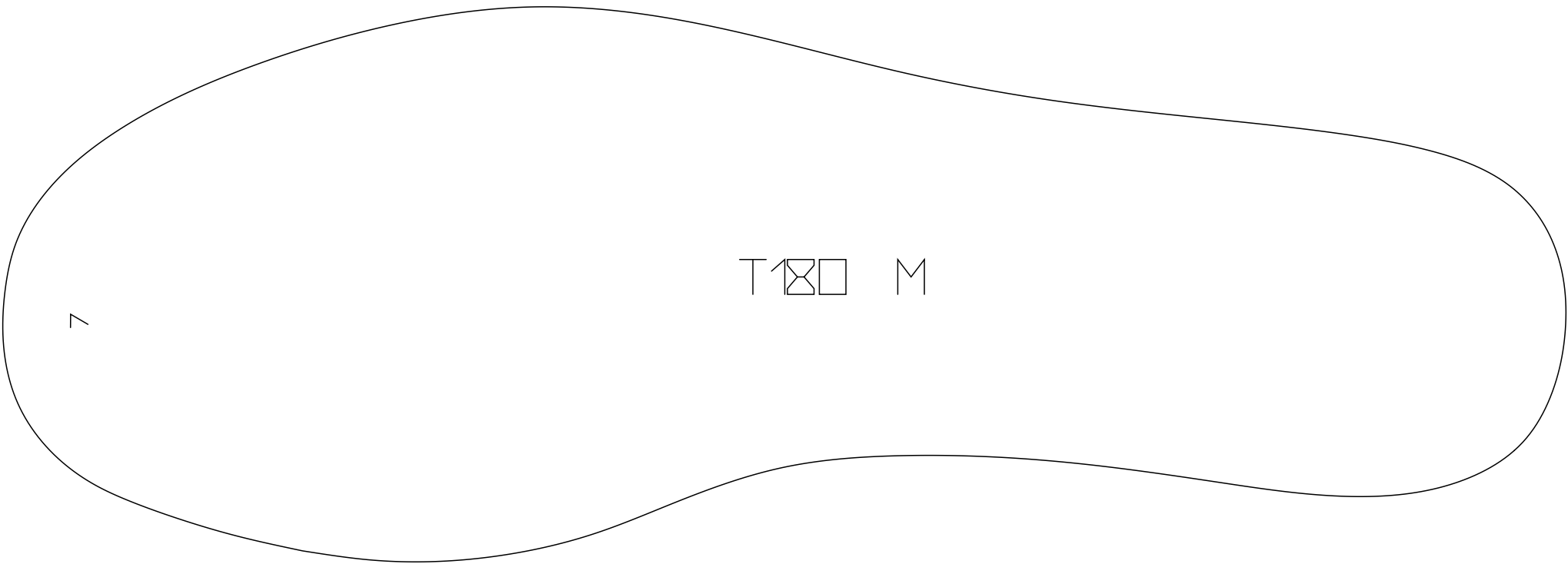

7

T180 M

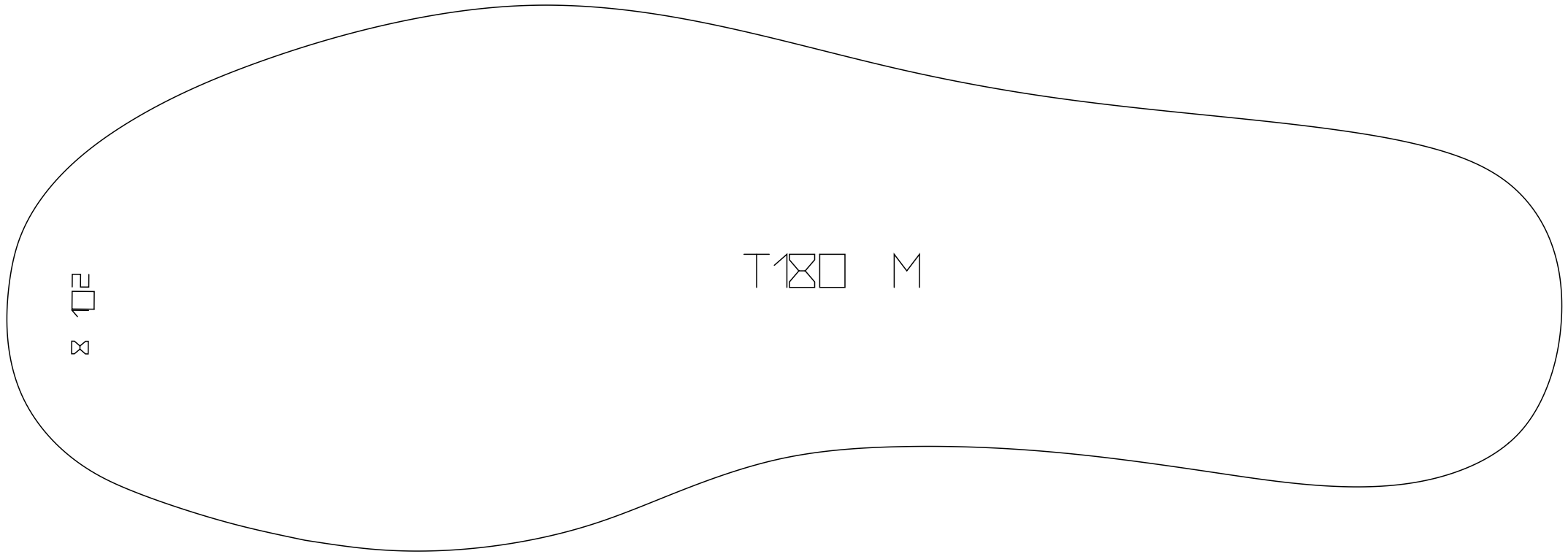

8 102

T180 M

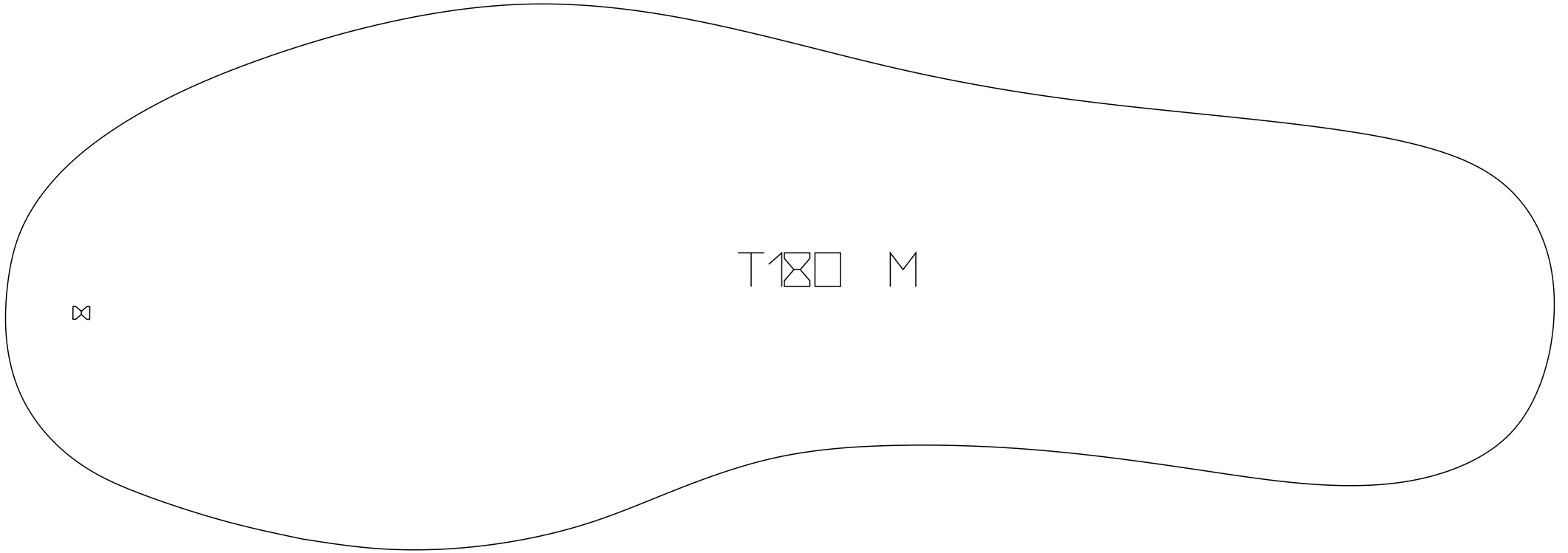

☒

T180 M

9 102

T180 M

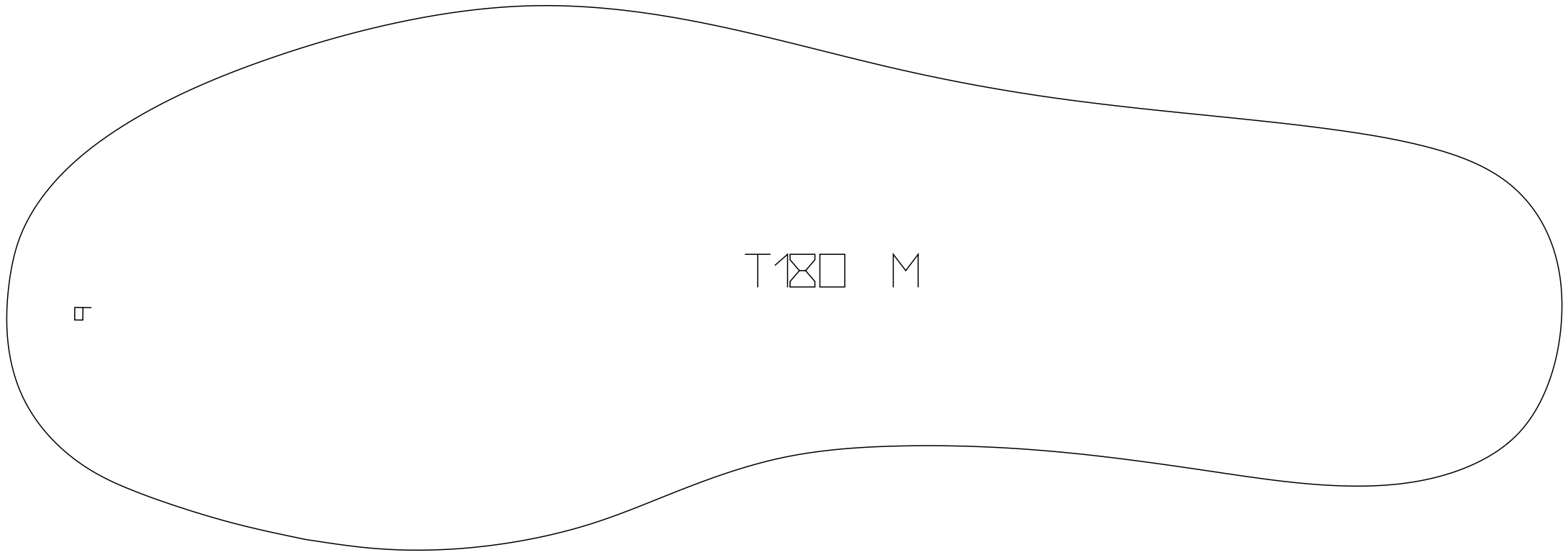

□

T180 M



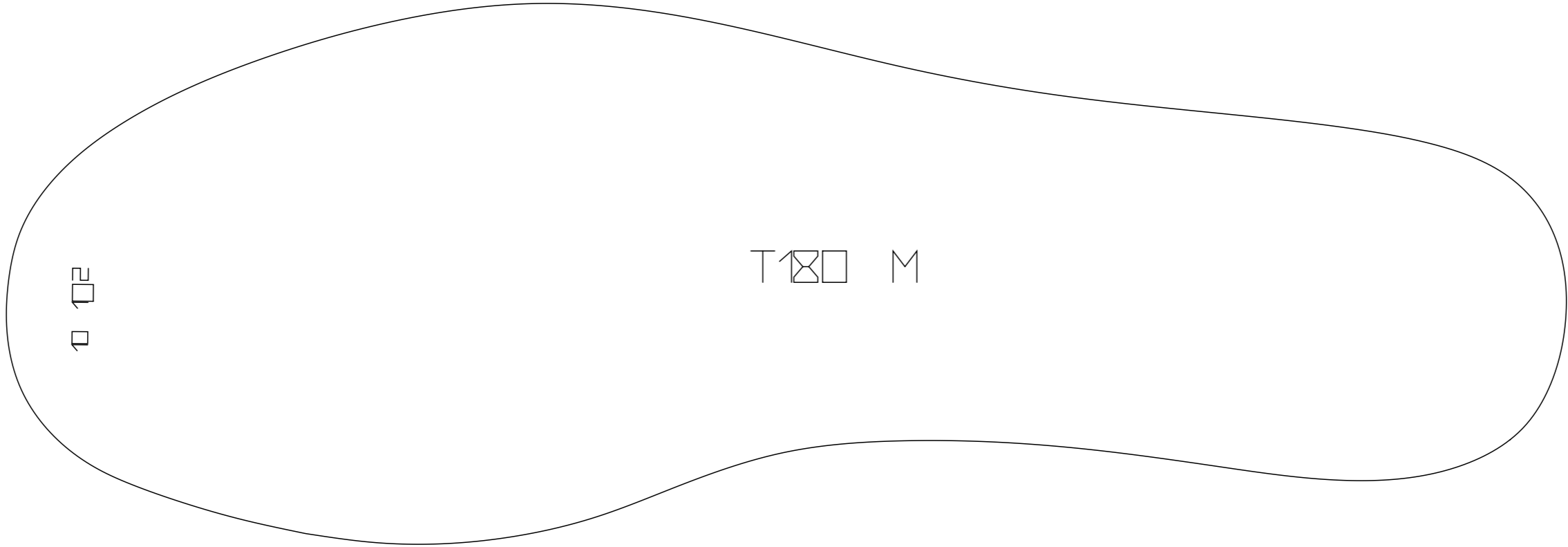

0 102

T180 M

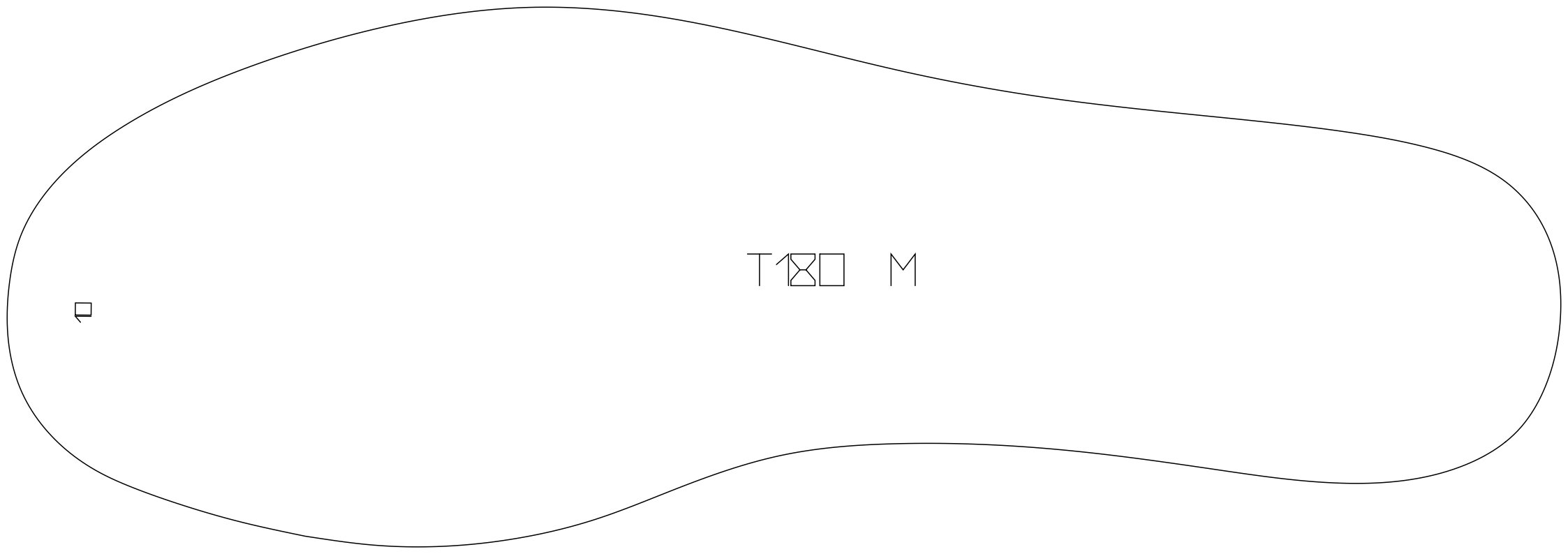

T180 M

